

Features

- 30V/50A,
 $R_{DS(ON)} = 4.2m\Omega(Typ.)@V_{GS}=10V$
 $R_{DS(ON)} = 6m\Omega(Typ.)@V_{GS}=4.5V$
- Advanced HEFET[®] Technology
- Ultra Low On-Resistance
- Excellent $Q_g \times R_{DS(on)}$ Product
- 100% avalanche tested
- Lead Free and Green Devices Available (RoHS Compliant)

Applications

- Uninterruptible Power Supplies
- Synchronous Rectification in DC/DC and AC/DC Converters

Pin Description

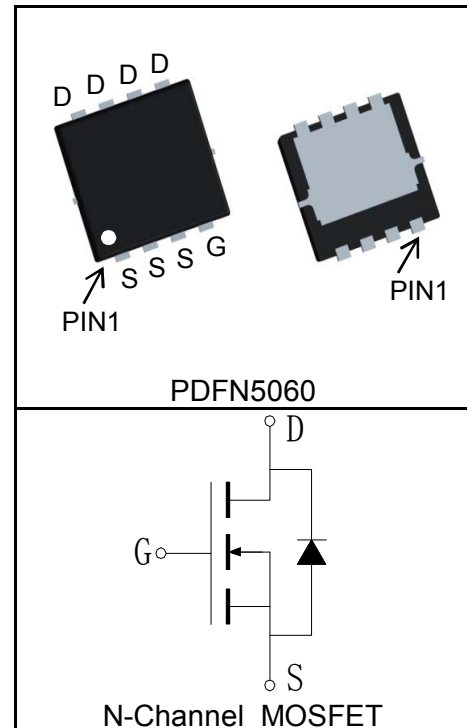

Absolute Maximum Ratings

Symbol	Parameter	Rating	Unit	
Common Ratings ($T_C=25^\circ C$ Unless Otherwise Noted)				
V_{DSS}	Drain-Source Voltage	30	V	
V_{GSS}	Gate-Source Voltage	± 20		
T_J	Maximum Junction Temperature	150	$^\circ C$	
T_{STG}	Storage Temperature Range	-55 to 150	$^\circ C$	
I_S	Diode Continuous Forward Current	$T_C=25^\circ C$	50	A
Mounted on Large Heat Sink				
$I_{DP}^{①}$	300 μs Pulse Drain Current Tested	$T_C=25^\circ C$	200	A
$I_D^{②}$	Continuous Drain Current@ $T_C(V_{GS}=10V)$	$T_C=25^\circ C$	50	A
		$T_C=100^\circ C$	32	
	Continuous Drain Current@ $T_A(V_{GS}=10V)^{③}$	$T_A=25^\circ C$	19	
		$T_A=70^\circ C$	15	
P_D	Maximum Power Dissipation@ T_C	$T_C=25^\circ C$	34	W
		$T_C=100^\circ C$	13	
	Maximum Power Dissipation@ $T_A^{③}$	$T_A=25^\circ C$	4.2	
		$T_A=70^\circ C$	2.7	

Symbol	Parameter	Rating	Unit
$R_{\theta JC}$	Thermal Resistance-Junction to Case	3.72	°C/W
$R_{\theta JA}$ ^③	Thermal Resistance-Junction to Ambient	30	°C/W
Drain-Source Avalanche Ratings			
E_{AS} ^④	Avalanche Energy, Single Pulsed	42	mJ

Electrical Characteristics ($T_C=25^\circ\text{C}$ Unless Otherwise Noted)

Symbol	Parameter	Test Condition	RUH3051M			Unit
			Min.	Typ.	Max.	
Static Characteristics						
BV_{DSS}	Drain-Source Breakdown Voltage	$V_{GS}=0V, I_{DS}=250\mu A$	30			V
I_{DSS}	Zero Gate Voltage Drain Current	$V_{DS}=30V, V_{GS}=0V$			1	μA
		$T_J=125^\circ C$			30	
$V_{GS(th)}$	Gate Threshold Voltage	$V_{DS}=V_{GS}, I_{DS}=250\mu A$	1		2.5	V
I_{GSS}	Gate Leakage Current	$V_{GS}=\pm 20V, V_{DS}=0V$			± 100	nA
$R_{DS(ON)}$ ^⑤	Drain-Source On-state Resistance	$V_{GS}=10V, I_{DS}=50A$		4.2	5.5	$m\Omega$
		$V_{GS}=4.5V, I_{DS}=35A$		6	8	$m\Omega$
Diode Characteristics						
V_{SD} ^⑤	Diode Forward Voltage	$I_{SD}=50A, V_{GS}=0V$			1.2	V
t_{rr}	Reverse Recovery Time	$I_{SD}=50A, di_{SD}/dt=100A/\mu s$		9		ns
Q_{rr}	Reverse Recovery Charge			15		nC
Dynamic Characteristics ^⑥						
R_G	Gate Resistance	$V_{GS}=0V, V_{DS}=0V, F=1MHz$		1.3		Ω
C_{iss}	Input Capacitance	$V_{GS}=0V,$ $V_{DS}=15V,$ Frequency=1.0MHz		580		pF
C_{oss}	Output Capacitance			130		
C_{rss}	Reverse Transfer Capacitance			20		
$t_{d(ON)}$	Turn-on Delay Time	$V_{DD}=15V, I_{DS}=50A,$ $V_{GEN}=10V, R_G=4.7\Omega$		6		ns
t_r	Turn-on Rise Time			12		
$t_{d(OFF)}$	Turn-off Delay Time			16		
t_f	Turn-off Fall Time			5		
Gate Charge Characteristics ^⑥						
Q_g	Total Gate Charge	$V_{DS}=24V, V_{GS}=10V,$ $I_{DS}=50A$		14		nC
Q_{gs}	Gate-Source Charge			4		
Q_{gd}	Gate-Drain Charge			5		

Notes:

- ①Pulse width limited by safe operating area.
- ②Calculated continuous current based on maximum allowable junction temperature.
- ③When mounted on 1 inch square copper board, $t \leq 10\text{sec}$.
- ④Limited by T_{Jmax} , $I_{AS} = 13\text{A}$, $V_{DD} = 24\text{V}$, $R_G = 50\Omega$, Starting $T_J = 25^\circ\text{C}$.
- ⑤Pulse test;Pulse width $\leq 300\mu\text{s}$, duty cycle $\leq 2\%$.
- ⑥Guaranteed by design, not subject to production testing.

Ordering and Marking Information

Device	Marking	Package	Packaging	Quantity	Reel Size	Tape width
RUH3051M	RUH3051M	PDFN5060	Tape&Reel	3000	13"	12mm

Typical Characteristics

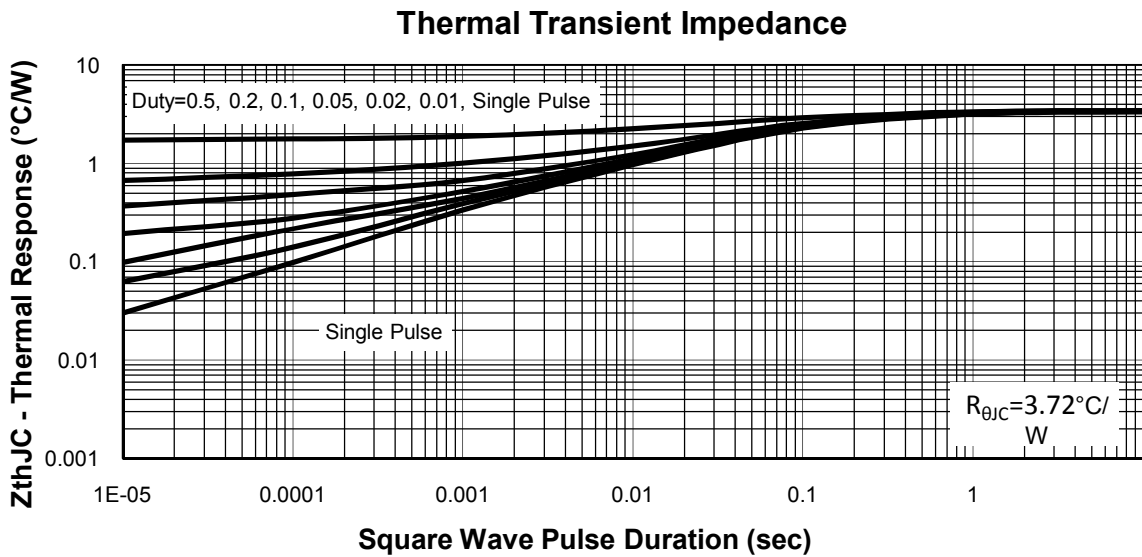
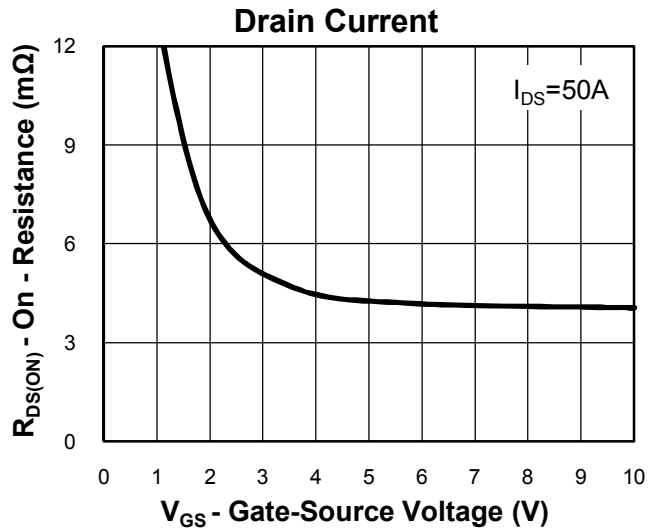
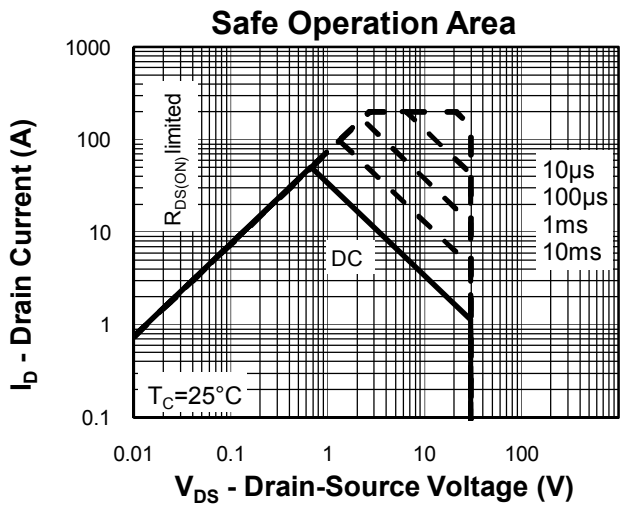
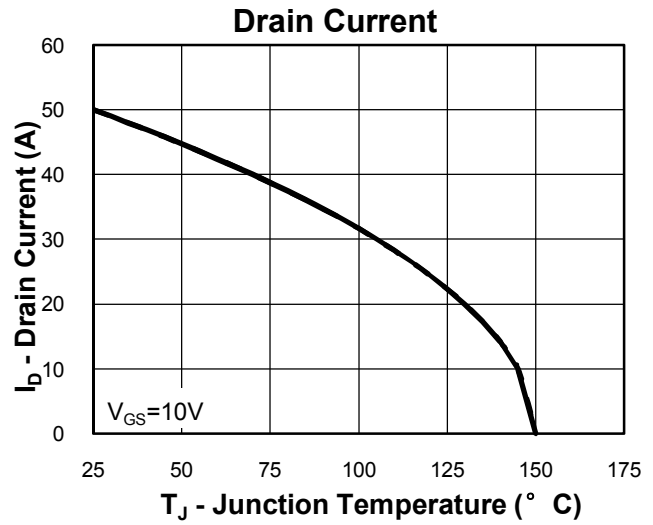
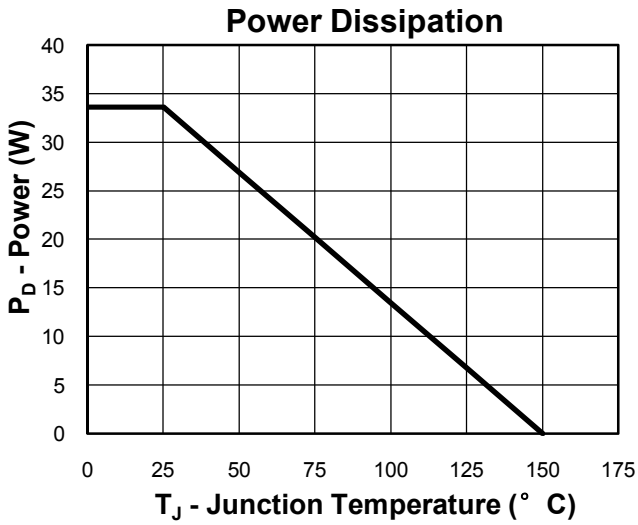

Typical Characteristics

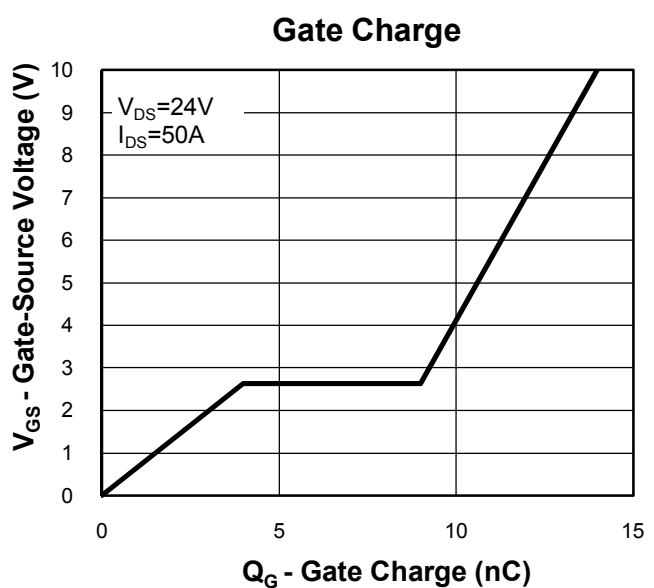
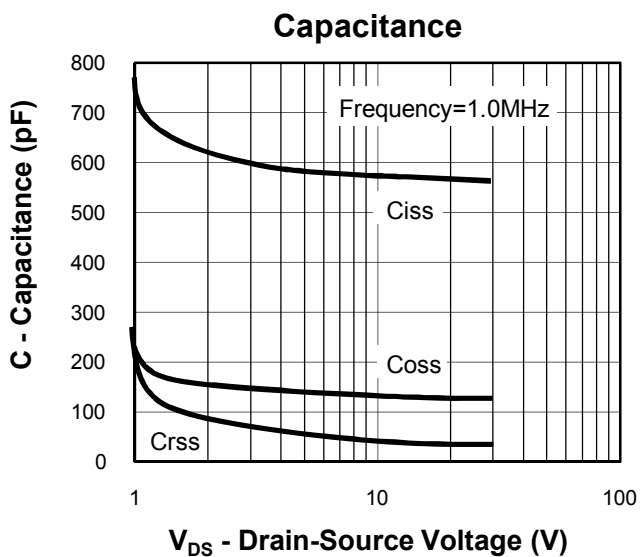
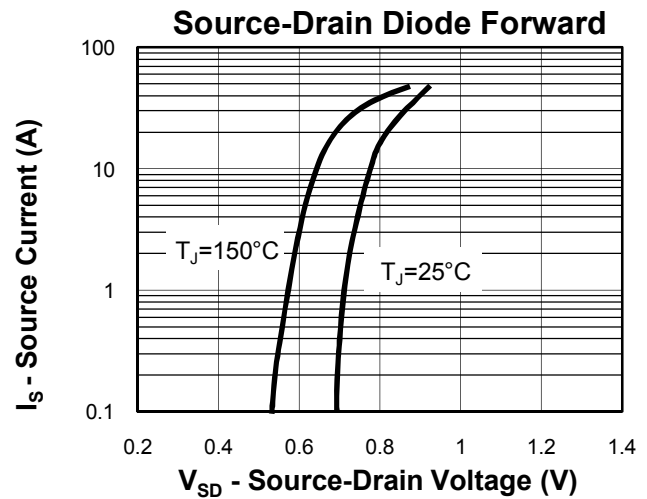
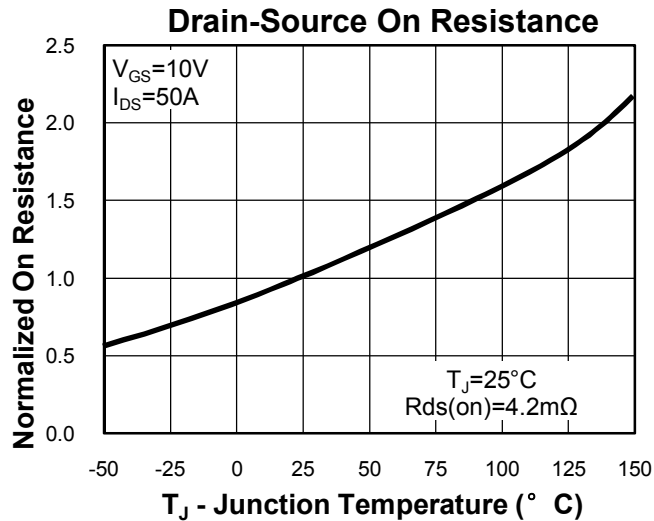
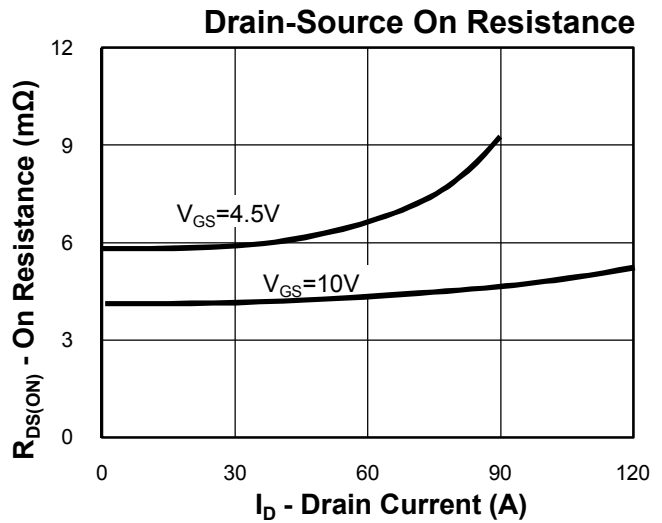
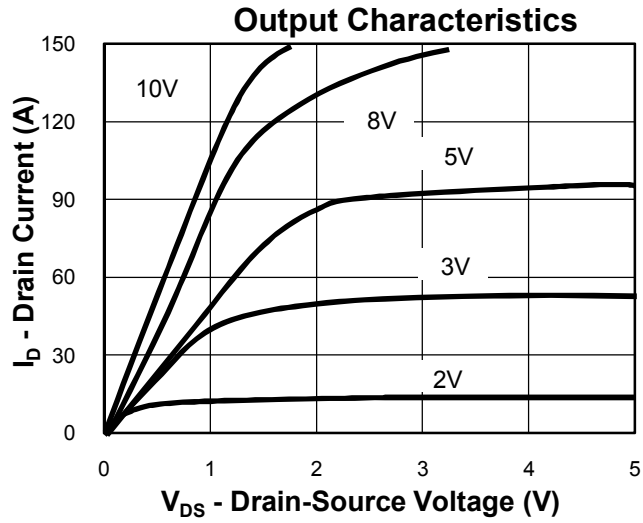

Avalanche Test Circuit and Waveforms

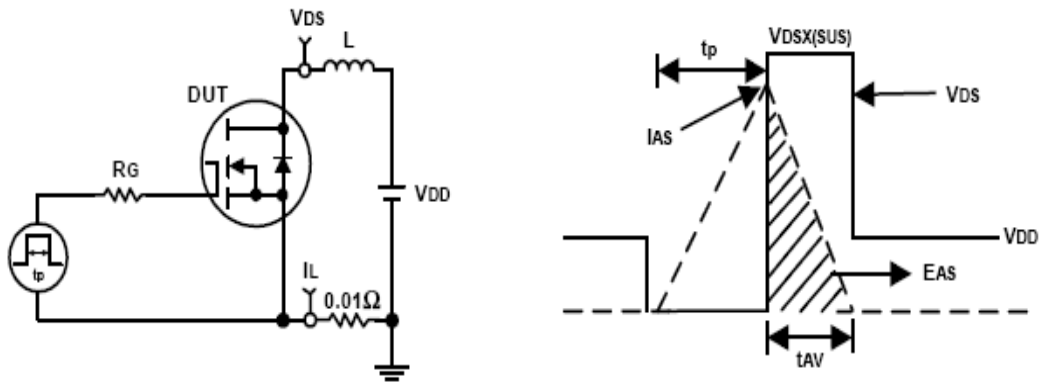

Switching Time Test Circuit and Waveforms

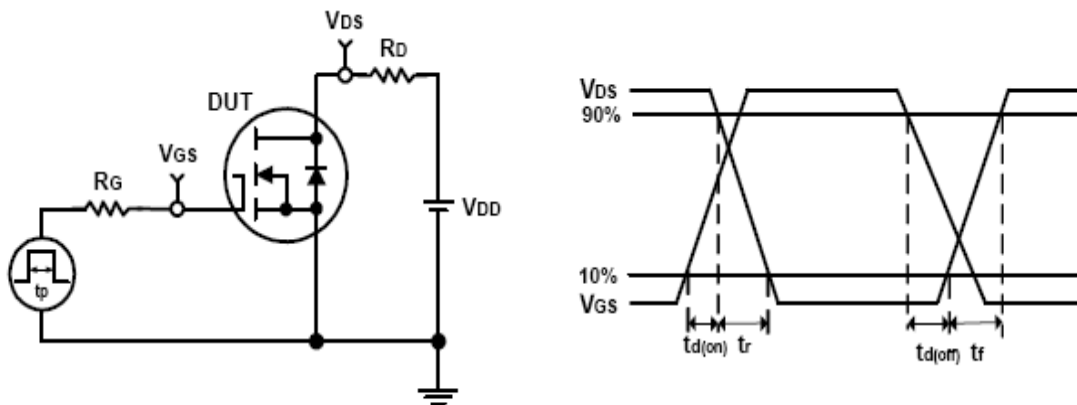

Package Information

PDFN5060

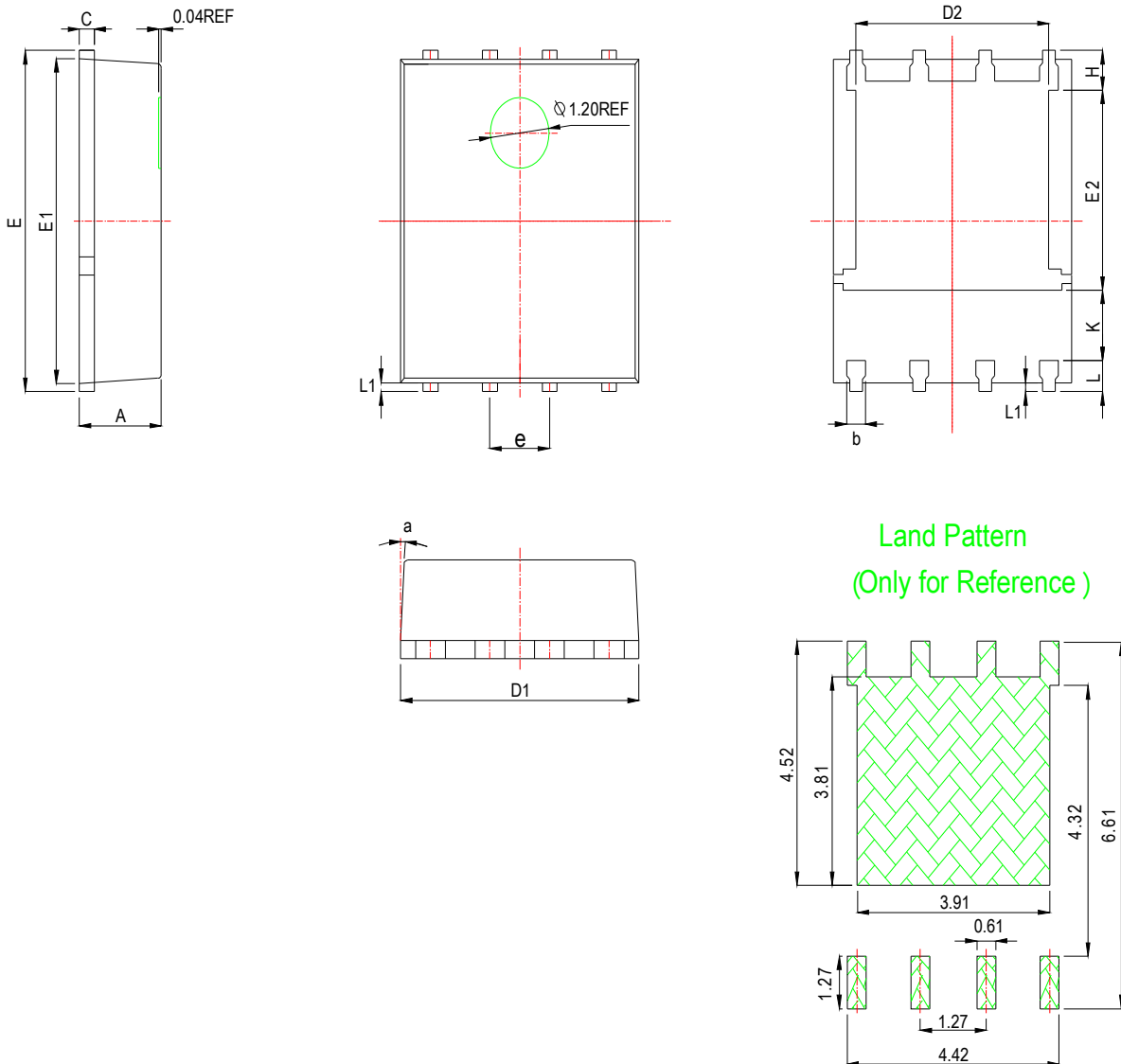

SYMBOL	MM			INCH		
	MIN	NOM	MAX	MIN	NOM	MAX
A	0.90	1.00	1.10	0.035	0.039	0.043
b	0.33	0.42	0.51	0.013	0.017	0.020
c	0.20	0.25	0.30	0.008	0.010	0.012
D1	4.80	4.90	5.00	0.189	0.193	0.197
D2	3.61	3.79	3.96	0.142	0.149	0.156
E	5.90	6.00	6.10	0.232	0.236	0.240
E1	5.65	5.75	5.85	0.222	0.226	0.230
E2	3.38	3.58	3.78	0.133	0.141	0.149
e	1.27 BSC			0.005 BSC		
H	0.41	0.51	0.61	0.016	0.020	0.024
k	1.10			0.043		
L	0.51	0.61	0.71	0.020	0.024	0.028
L1	0.06	0.13	0.20	0.002	0.005	0.008
a	0°		12°	0°		12°

Customer Service**Worldwide Sales and Service:**

Sales@ruichips.com

Technical Support:

Technical@ruichips.com

Investor Relations Contacts:

Investor@ruichips.com

Marcom Contact:

Marcom@ruichips.com

Editorial Contact:

Editorial@ruichips.com

HR Contact:

HR@ruichips.com

Legal Contact:

Legal@ruichips.com

Shen Zhen RUICHIPS Semiconductor CO., LTD

4th Floor, Block 8, Changyuan New Material Port, Keyuan Middle Road, Science & Industry Park,
Nanshan District, Shenzhen, CHINA

TEL: (86-755) 8311-5334

FAX: (86-755) 8311-4278

E-mail: Sales-SZ@ruichips.com